

Becafire

by Bernard Cailliau

Model BECATRANS CUB'R 800x600

Dimensions (mm)

- combustion opening WxDxH -
- glass door WxH -
- external WxDxH 817 x 445 x 622
- stoke grate WxD -
- fresh air -
- diam. flue -

Technical Data

- combustion opening WxDxH -

Specifications

- finishing heat-resistant black paint
- cast iron stoke grate
- 1 opening door in heat-resistant glass
- sides: ribbed cast iron

Options

-

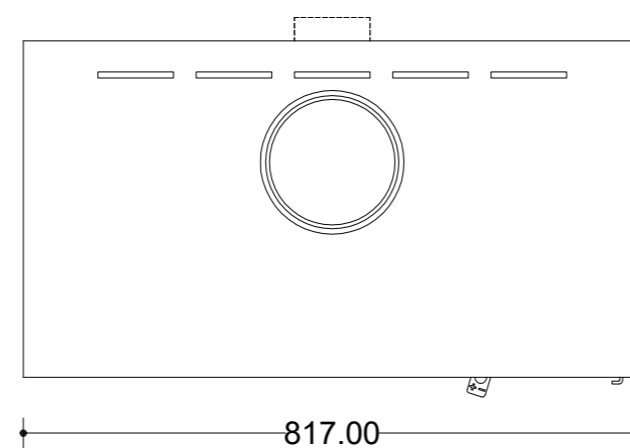
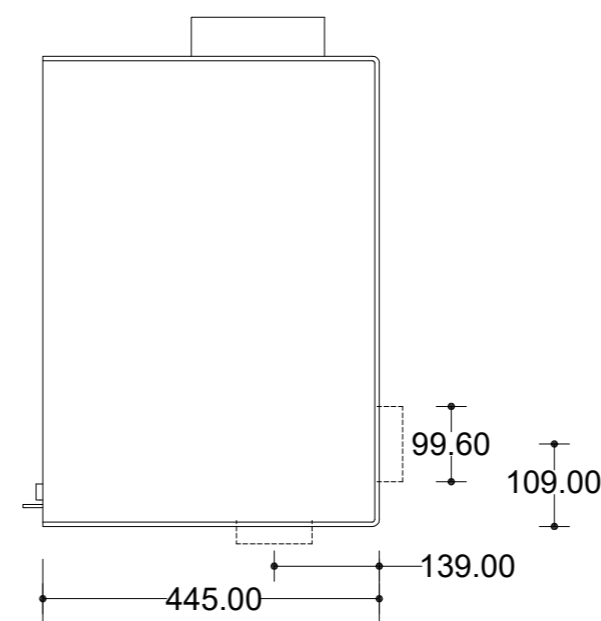
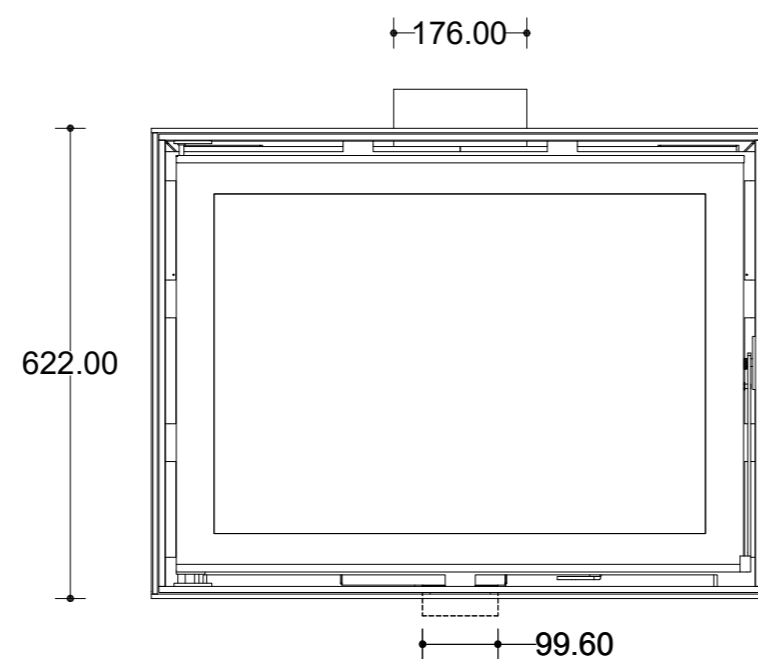

www.becafire.com